

## ADCMP563/ADCMP564

### FEATURES

- Differential ECL compatible outputs
- 700 ps propagation delay input to output
- 75 ps propagation delay dispersion
- Input common-mode range:  $-2.0\text{ V}$  to  $+3.0\text{ V}$
- Robust input protection
- Differential latch control
- Internal latch pull-up resistors
- Power supply rejection greater than 85 dB
- 700 ps minimum pulse width
- 1.5 GHz equivalent input rise time bandwidth
- Typical output rise/fall time of 500 ps
- ESD protection  $> 4\text{ kV HBM}$ ,  $> 200\text{ V MM}$
- Programmable hysteresis

### APPLICATIONS

- Automatic test equipment
- High speed instrumentation
- Scope and logic analyzer front ends
- Window comparators
- High speed line receivers
- Threshold detection
- Peak detection
- High speed triggers
- Patient diagnostics
- Disk drive read channel detection
- Hand-held test instruments
- Zero crossing detectors
- Line receivers and signal restoration
- Clock drivers

### GENERAL DESCRIPTION

The ADCMP563/ADCMP564 are high speed comparators fabricated on Analog Devices' proprietary XFCB process. The devices feature a 700 ps propagation delay with less than 75 ps overdrive dispersion. Dispersion, a measure of the difference in propagation delay under differing overdrive conditions, is a particularly important characteristic of high speed comparators. A separate programmable hysteresis pin is available on the ADCMP564.

A differential input stage permits consistent propagation delay with a wide variety of signals in the common-mode range from

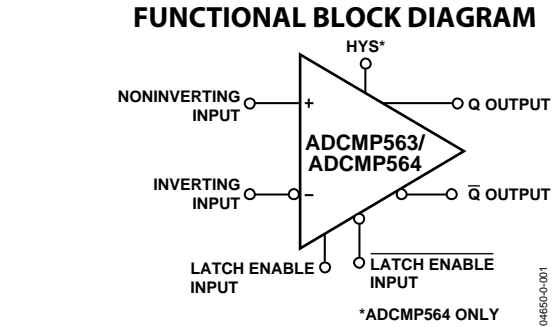

Figure 1.

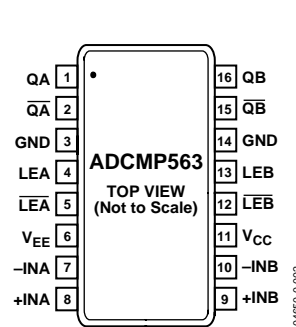

Figure 2. ADCMP563 16-Lead QSOP

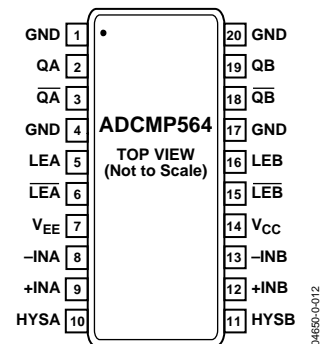

Figure 3. ADCMP564 20-Lead QSOP

$-2.0\text{ V}$  to  $+3.0\text{ V}$ . Outputs are complementary digital signals that are fully compatible with ECL 10 K and 10 KH logic families. The outputs provide sufficient drive current to directly drive transmission lines terminated in  $50\ \Omega$  to  $-2\text{ V}$ . A latch input, which is included, permits tracking, track-and-hold, or sample-and-hold modes of operation. The latch input pins contain internal pull-ups that set the latch in tracking mode when left open.

The ADCMP563/ADCMP564 are specified over the industrial temperature range ( $-40^\circ\text{C}$  to  $+85^\circ\text{C}$ ).

#### Rev. A

Information furnished by Analog Devices is believed to be accurate and reliable. However, no responsibility is assumed by Analog Devices for its use, nor for any infringements of patents or other rights of third parties that may result from its use. Specifications subject to change without notice. No license is granted by implication or otherwise under any patent or patent rights of Analog Devices. Trademarks and registered trademarks are the property of their respective owners.

## TABLE OF CONTENTS

Specifications.....	3	Clock Timing Recovery.....	11
Absolute Maximum Ratings.....	5	Optimizing High Speed Performance .....	11
Thermal Considerations.....	5	Comparator Propagation Delay Dispersion .....	11
ESD Caution.....	5	Comparator Hysteresis .....	12
Pin Configurations and Function Descriptions .....	6	Minimum Input Slew Rate Requirement .....	12
Typical Performance Characteristics .....	8	Typical Application Circuits.....	13
Timing Information .....	10	Outline Dimensions .....	14
Application Information.....	11	Ordering Guide .....	14

## REVISION HISTORY

### 7/04—Data Sheet Changed from Rev. 0 to Rev. A

Changes to Specification Table .....	4
Changes to Figure 14.....	9
Changes to Figure 21 .....	12
Changes to Figure 23.....	13

### 4/04—Revision 0: Initial Version

# SPECIFICATIONS

$V_{CC} = +5.0\text{ V}$ ,  $V_{EE} = -5.2\text{ V}$ ,  $T_A = -40^\circ\text{C}$  to  $+85^\circ\text{C}$ . Typical values are at  $T_A = +25^\circ\text{C}$ , unless otherwise noted.

**Table 1. Electrical Characteristics**

Parameter	Symbol	Conditions	Min	Typ	Max	Unit
<b>DC INPUT CHARACTERISTICS</b>						
Input Voltage Range			-2.0		3.0	V
Input Differential Voltage			-5		+5	V
Input Offset Voltage	$V_{OS}$	$V_{CM} = 0\text{ V}$	-10.0	$\pm 2.0$	+10.0	mV
Input Offset Voltage Channel Matching				$\pm 2.0$		mV
Offset Voltage Tempco	$\Delta V_{OS}/d_T$			2.0		$\mu\text{V}/^\circ\text{C}$
Input Bias Current	$I_{BC}$	@ $-IN = -2\text{ V}$ , $+IN = +3\text{ V}$	-10.0	$\pm 3$	+10.0	$\mu\text{A}$
Input Bias Current Tempco				0.5		$\text{nA}/^\circ\text{C}$
Input Offset Current				$\pm 1.0$		$\mu\text{A}$
Input Capacitance	$C_{IN}$			0.75		pF
Input Resistance, Differential Mode				750		k $\Omega$
Input Resistance, Common Mode				1800		k $\Omega$
Active Gain	$A_V$			63		dB
Common-Mode Rejection Ratio	CMRR	$V_{CM} = -2.0\text{ V}$ to $+3.0\text{ V}$		80		dB
Hysteresis		$R_{HYS} = \infty$		$\pm 1.0$		mV
<b>LATCH ENABLE CHARACTERISTICS</b>						
Latch Enable Voltage Range			-2.0		0	V
Latch Enable Differential Input Voltage			0.4		2.0	V
Latch Enable Input High Current		@ 0.0 V	-300		+300	$\mu\text{A}$
Latch Enable Input Low Current		@ -2.0 V	-300		+300	$\mu\text{A}$
LE Voltage, Open		Latch inputs not connected	-0.2	0	+0.1	V
$\overline{\text{LE}}$ Voltage, Open		Latch inputs not connected	-2.8	-2.6	-2.4	V
Latch Setup Time	$t_S$	$V_{OD} = 250\text{ mV}$		200		ps
Latch Hold Time	$t_H$	$V_{OD} = 250\text{ mV}$		200		ps
Latch to Output Delay	$t_{PLOH}$ , $t_{PLOL}$	$V_{OD} = 250\text{ mV}$		500		ps
Latch Minimum Pulse Width	$t_{PL}$	$V_{OD} = 250\text{ mV}$		500		ps
<b>DC OUTPUT CHARACTERISTICS</b>						
Output Voltage—High Level	$V_{OH}$	ECL 50 $\Omega$ to -2.0 V	-1.15		-0.81	V
Output Voltage—Low Level	$V_{OL}$	ECL 50 $\Omega$ to -2.0 V	-1.95		-1.54	V
Rise Time	$t_R$	10% to 90%		530		ps
Fall Time	$t_F$	10% to 90%		450		ps
<b>AC PERFORMANCE</b>						
Propagation Delay	$t_{PD}$	$V_{OD} = 1\text{ V}$ $V_{OD} = 20\text{ mV}$		700		ps
Propagation Delay Tempco	$\Delta t_{PD}/d_T$	$V_{OD} = 1\text{ V}$		830		ps
Prop Delay Skew—Rising Transition to Falling Transition		$V_{OD} = 1\text{ V}$		0.25		$\text{ps}/^\circ\text{C}$
Within Device Propagation Delay Skew—Channel-to-Channel		$V_{OD} = 1\text{ V}$		50		ps
Overdrive Dispersion		$20\text{ mV} \leq V_{OD} \leq 100\text{ mV}$ $100\text{ mV} \leq V_{OD} \leq 1.5\text{ V}$		50		ps
Slew Rate Dispersion		$0.4\text{ V/ns} \leq SR \leq 1.33\text{ V/ns}$		75		ps
Pulse Width Dispersion		$750\text{ ps} \leq PW \leq 10\text{ ns}$		75		ps
Duty Cycle Dispersion		33 MHz, 1 V/ns, 0.5 V		25		ps
Common-Mode Voltage Dispersion		1 V swing, $-1.5\text{ V} \leq V_{CM} \leq +2.5\text{ V}$		10		ps

# ADCMP563/ADCMP564

Parameter	Symbol	Conditions	Min	Typ	Max	Unit
AC PERFORMANCE (continued)						
Equivalent Input Rise Time Bandwidth <sup>1</sup>	BW <sub>EQ</sub>	0 V to 1 V swing, 2 V/ns		1500		MHz
Maximum Toggle Rate		>50% output swing, 50% duty cycle		800		MHz
Minimum Pulse Width	PW <sub>MIN</sub>	$\Delta t_{PD} < 25$ ps		700		ps
RMS Random Jitter		V <sub>OD</sub> = 400 mV, 1.3 V/ns, 312 MHz, 50% duty cycle		1.0		ps
Unit to Unit Propagation Delay Skew				100		ps
POWER SUPPLY						
Positive Supply Current	I <sub>VCC</sub>	@ +5.0 V	2	3.2	5	mA
Negative Supply Current	I <sub>VEE</sub>	@ -5.2 V	10	19	25	mA
Positive Supply Voltage	V <sub>CC</sub>	Dual	4.75	5.0	5.25	V
Negative Supply Voltage	V <sub>EE</sub>	Dual	-4.96	-5.2	-5.45	V
Power Dissipation	P <sub>D</sub>	Dual, without load	90	120	150	mW
		Dual, with load	150	180	230	mW
DC Power Supply Rejection Ratio—V <sub>CC</sub>	PSRR <sub>VCC</sub>			85		dB
DC Power Supply Rejection Ratio—V <sub>EE</sub>	PSRR <sub>VEE</sub>			85		dB
HYSTERESIS (ADCMP564 Only)						
Hysteresis		R <sub>HYS</sub> = 23.5 k $\Omega$		20		mV
		R <sub>HYS</sub> = 9.0 k $\Omega$		70		mV

<sup>1</sup> Equivalent input rise time bandwidth assumes a first-order input response and is calculated by the following formula:  $BW_{EQ} = 0.22/\sqrt{(tr_{COMP}^2 - tr_{IN}^2)}$ , where  $tr_{IN}$  is the 20/80 input transition time applied to the comparator and  $tr_{COMP}$  is the effective transition time, as digitized by the comparator input.

## ABSOLUTE MAXIMUM RATINGS

Table 2.

Parameter	Rating
Supply Voltages	
Positive Supply Voltage ( $V_{CC}$ to GND)	-0.5 V to +6.0 V
Negative Supply Voltage ( $V_{EE}$ to GND)	-6.0 V to +0.5 V
Ground Voltage Differential	-0.5 V to +0.5 V
Input Voltages	
Input Common-Mode Voltage	-3.0 V to +4.0 V
Differential Input Voltage	-7.0 V to +7.0 V
Input Voltage, Latch Controls	$V_{EE}$ to +0.5 V
Output	
Output Current	30 mA
Temperature	
Operating Temperature, Ambient	-40°C to +85°C
Operating Temperature, Junction	125°C
Storage Temperature Range	-65°C to +150°C

Stresses above those listed under Absolute Maximum Ratings may cause permanent damage to the device. This is a stress rating only; functional operation of the device at these or any other conditions above those indicated in the operational sections of this specification is not implied. Exposure to absolute maximum rating conditions for extended periods may affect device reliability.

### THERMAL CONSIDERATIONS

The ADCMP563 QSOP 16-lead package option has a  $\theta_{JA}$  (junction-to-ambient thermal resistance) of 104°C/W in still air.

The ADCMP564 QSOP 20-lead package option has a  $\theta_{JA}$  (junction-to-ambient thermal resistance) of 80°C/W in still air.

### ESD CAUTION

ESD (electrostatic discharge) sensitive device. Electrostatic charges as high as 4000 V readily accumulate on the human body and test equipment and can discharge without detection. Although this product features proprietary ESD protection circuitry, permanent damage may occur on devices subjected to high energy electrostatic discharges. Therefore, proper ESD precautions are recommended to avoid performance degradation or loss of functionality.



# ADCMP563/ADCMP564

## PIN CONFIGURATIONS AND FUNCTION DESCRIPTIONS

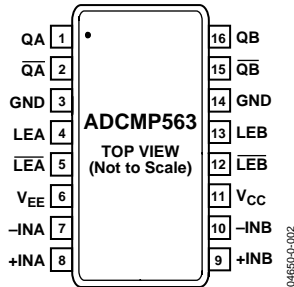

Figure 4. ADCMP563 16-Lead QSOP Pin Configuration

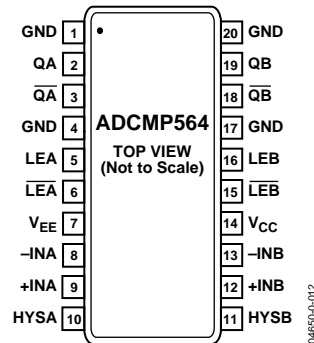

Figure 5. ADCMP564 20-Lead QSOP Pin Configuration

Table 3. Pin Function Descriptions

Pin No.		Mnemonic	Function
ADCMP563	ADCMP564		
1	1	GND	Analog Ground.
2	2	QA	One of two complementary outputs for Channel A. QA is logic high if the analog voltage at the noninverting input is greater than the analog voltage at the inverting input (provided the comparator is in compare mode). See the description of Pin LEA for more information.
3	3	QA-bar	One of two complementary outputs for Channel A. QA-bar is logic low if the analog voltage at the noninverting input is greater than the analog voltage at the inverting input (provided the comparator is in compare mode). See the description of Pin LEA for more information.
4	4	GND	Analog Ground.
5	5	LEA	One of two complementary inputs for Channel A Latch Enable. In compare mode (logic high), the output tracks changes at the input of the comparator. In latch mode (logic low), the output reflects the input state just prior to the comparator being placed in the latch mode. LEA must be driven in conjunction with LEA-bar. If left unconnected, the comparator defaults to compare mode.
6	6	LEA-bar	One of two complementary inputs for Channel A Latch Enable. In compare mode (logic low), the output tracks changes at the input of the comparator. In latch mode (logic high), the output reflects the input state just prior to the comparator being placed in the latch mode. LEA must be driven in conjunction with LEA-bar. If left unconnected, the comparator defaults to compare mode.
7	7	VEE	Negative Supply Terminal.
8	8	-INA	Inverting Analog Input of the Differential Input Stage for Channel A. The inverting A input must be driven in conjunction with the noninverting A input.
9	9	+INA	Noninverting Analog Input of the Differential Input Stage for Channel A. The noninverting A input must be driven in conjunction with the inverting A input.
10	10	HYSA	Programmable Hysteresis Input.
11	11	HYSB	Programmable Hysteresis Input.
12	12	+INB	Noninverting Analog Input of the Differential Input Stage for Channel B. The noninverting B input must be driven in conjunction with the inverting B input.
13	13	-INB	Inverting Analog Input of the Differential Input Stage for Channel B. The inverting B input must be driven in conjunction with the noninverting B input.
14	14	VCC	Positive Supply Terminal.
15	15	LEB	One of two complementary inputs for Channel B Latch Enable. In compare mode (logic low), the output tracks changes at the input of the comparator. In latch mode (logic high), the output reflects the input state just prior to the comparator being placed in the latch mode. LEB must be driven in conjunction with LEB-bar. If left unconnected, the comparator defaults to compare mode.

Pin No.		Mnemonic	Function
ADCMP563	ADCMP564		
13	16	LEB	One of two complementary inputs for Channel B Latch Enable. In compare mode (logic high), the output tracks changes at the input of the comparator. In latch mode (logic low), the output reflects the input state just prior to the comparator being placed in the latch mode. $\overline{LEB}$ must be driven in conjunction with LEB. If left unconnected, the comparator defaults to compare mode.
14	17	GND	Analog Ground.
15	18	$\overline{QB}$	One of two complementary outputs for Channel B. $\overline{QB}$ is logic low if the analog voltage at the noninverting input is greater than the analog voltage at the inverting input (provided the comparator is in compare mode). See the description of Pin LEB for more information.
16	19	QB	One of two complementary outputs for Channel B. QB is logic high if the analog voltage at the noninverting input is greater than the analog voltage at the inverting input (provided the comparator is in compare mode). See the description of Pin LEB for more information.
	20	GND	Analog Ground.

## TYPICAL PERFORMANCE CHARACTERISTICS

$V_{CC} = 3.3\text{ V}$ ,  $T_A = 25^\circ\text{C}$ , unless otherwise noted.

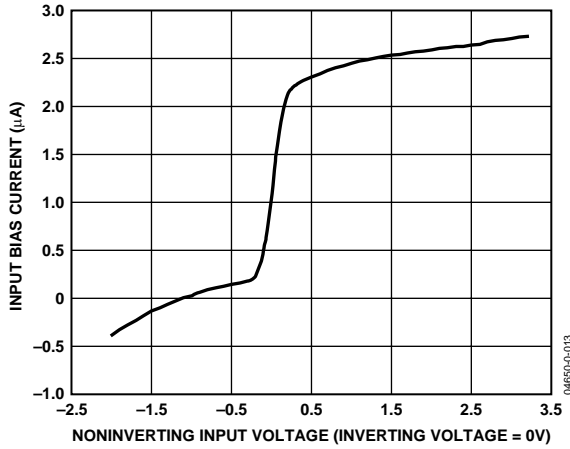

Figure 6. Input Bias Current vs. Input Voltage

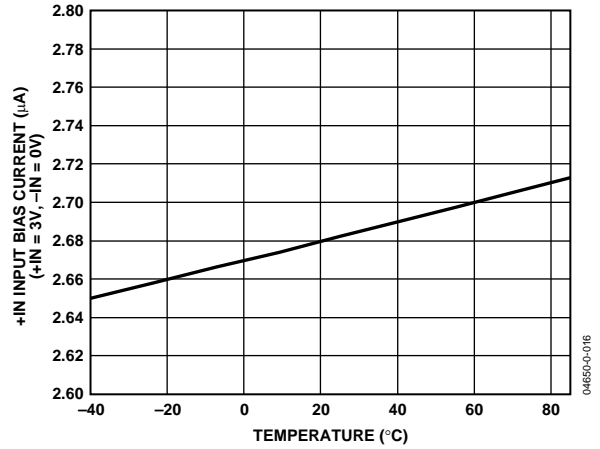

Figure 9. Input Bias Current vs. Temperature

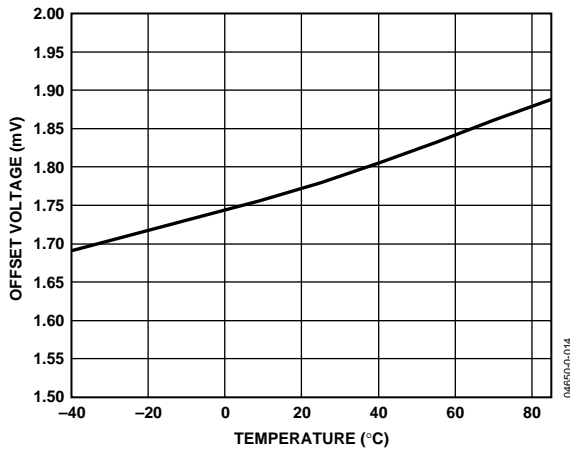

Figure 7. Input Offset Voltage vs. Temperature

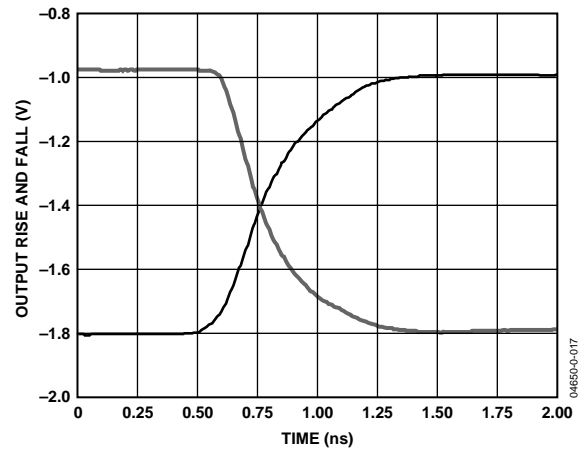

Figure 10. Rise and Fall of Outputs vs. Time

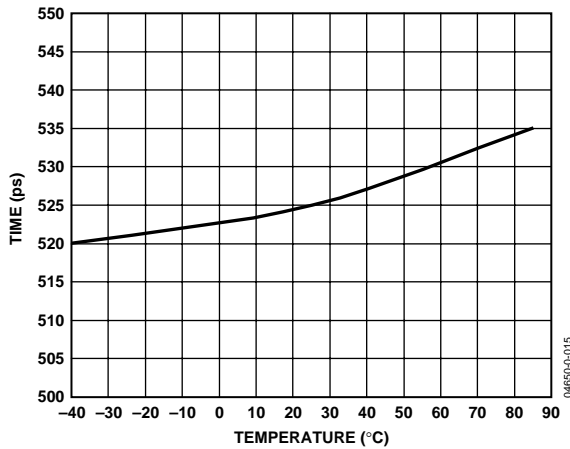

Figure 8. Rise Time vs. Temperature

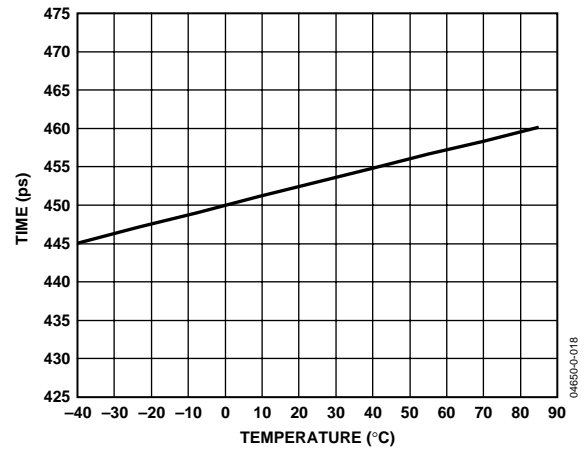

Figure 11. Fall Time vs. Temperature



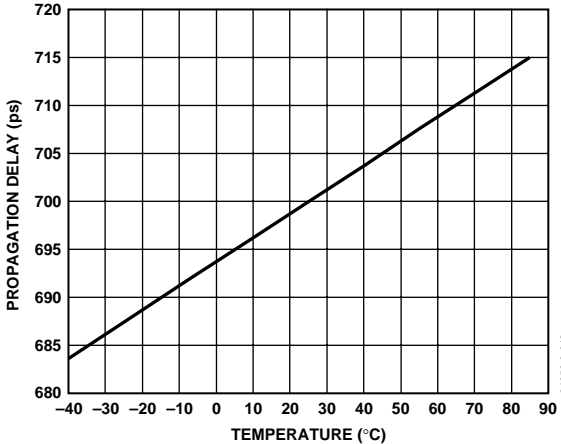

Figure 12. Propagation Delay vs. Temperature

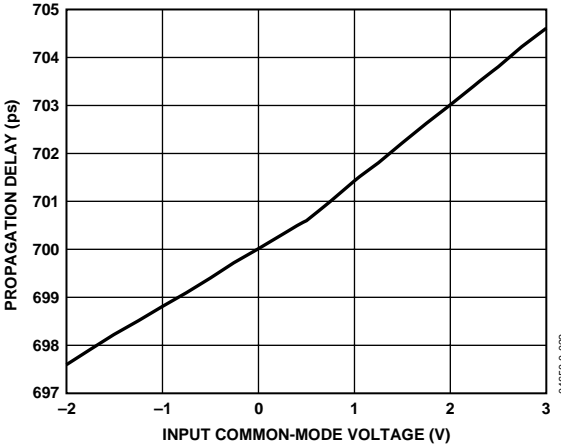

Figure 15. Propagation Delay vs. Common-Mode Voltage

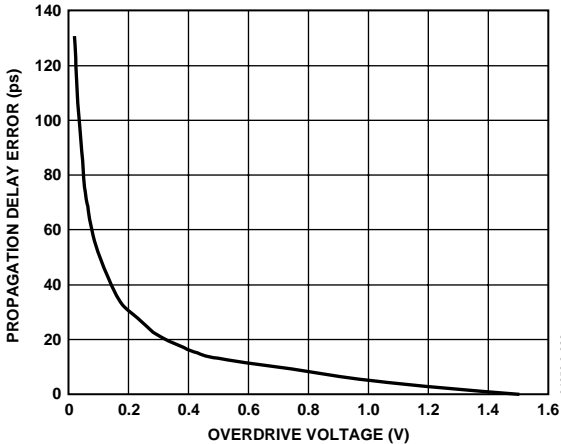

Figure 13. Propagation Delay vs. Overdrive Voltage

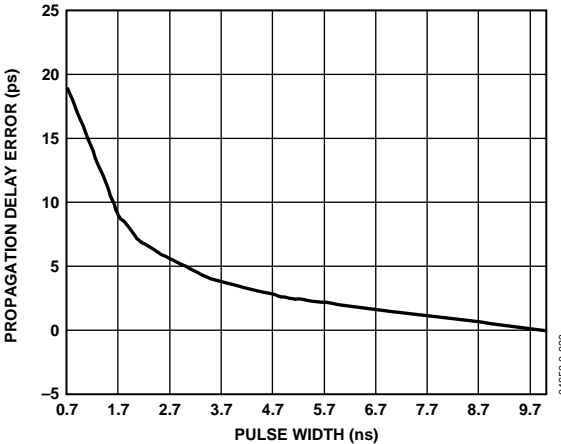

Figure 16. Propagation Delay Error vs. Pulse Width

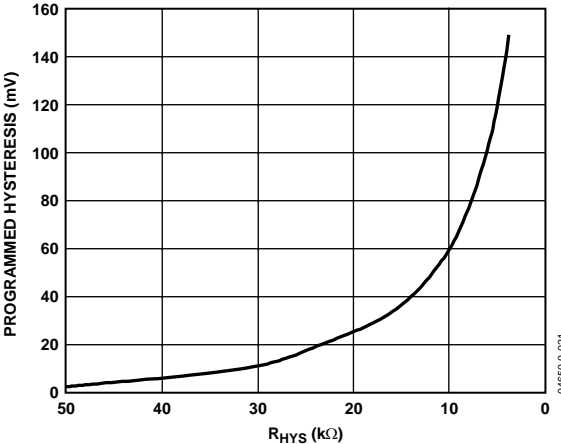

Figure 14. Comparator Hysteresis vs. R<sub>HYS</sub>

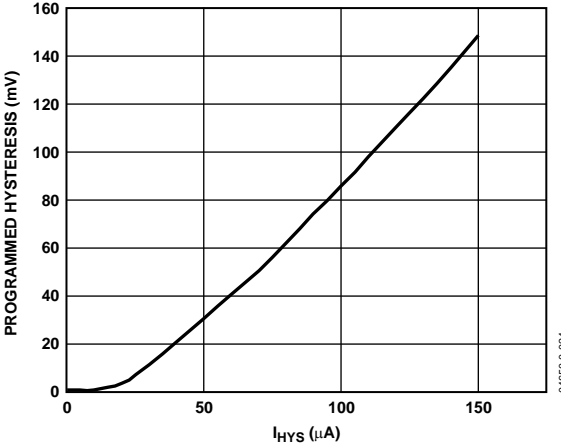

Figure 17. Comparator Hysteresis vs. I<sub>HYS</sub>

## TIMING INFORMATION

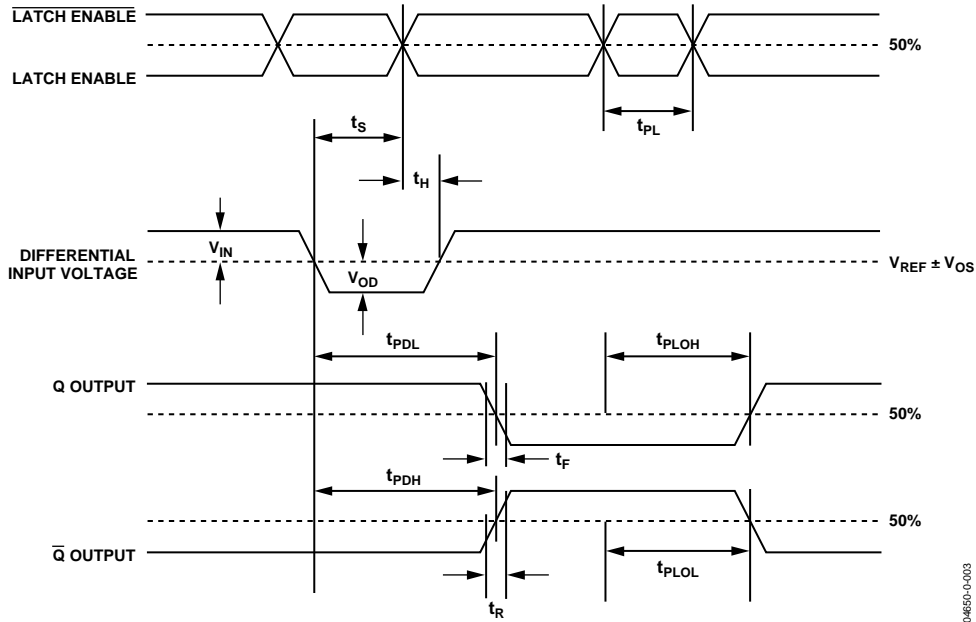

Figure 18. System Timing Diagram

Figure 18 shows the compare and latch features of the ADCMP563. Table 4 describes the terms in the diagram.

Table 4. Timing Descriptions

Symbol	Timing	Description
$t_{PDH}$	Input to Output High Delay	Propagation delay measured from the time the input signal crosses the reference ( $\pm$ the input offset voltage) to the 50% point of an output low-to-high transition.
$t_{PDL}$	Input to Output Low Delay	Propagation delay measured from the time the input signal crosses the reference ( $\pm$ the input offset voltage) to the 50% point of an output high-to-low transition.
$t_{PLOH}$	Latch Enable to Output High Delay	Propagation delay measured from the 50% point of the latch enable signal low-to-high transition to the 50% point of an output low-to-high transition.
$t_{PLOL}$	Latch Enable to Output Low Delay	Propagation delay measured from the 50% point of the latch enable signal low-to-high transition to the 50% point of an output high-to-low transition.
$t_H$	Minimum Hold Time	Minimum time after the negative transition of the latch enable signal that the input signal must remain unchanged to be acquired and held at the outputs.
$t_{PL}$	Minimum Latch Enable Pulse Width	Minimum time the latch enable signal must be high to acquire an input signal change.
$t_S$	Minimum Setup Time	Minimum time before the negative transition of the latch enable signal that an input signal change must be present to be acquired and held at the outputs.
$t_R$	Output Rise Time	Amount of time required to transition from a low to a high output as measured at the 20% and 80% points.
$t_F$	Output Fall Time	Amount of time required to transition from a high to a low output as measured at the 20% and 80% points.
$V_{OD}$	Voltage Overdrive	Difference between the differential input and reference input voltages.

## APPLICATION INFORMATION

The ADCMP563/ADCMP564 comparators are very high speed devices. Consequently, high speed design techniques must be employed to achieve the best performance. The most critical aspect of any ADCMP563/ADCMP564 design is the use of a low impedance ground plane. A ground plane, as part of a multilayer board, is recommended for proper high speed performance. Using a continuous conductive plane over the surface of the circuit board can create this, allowing breaks in the plane only for necessary signal paths. The ground plane provides a low inductance ground, eliminating any potential differences at different ground points throughout the circuit board caused by ground bounce. A proper ground plane also minimizes the effects of stray capacitance on the circuit board.

It is also important to provide bypass capacitors for the power supply in a high speed application. A 1  $\mu\text{F}$  electrolytic bypass capacitor should be placed within 0.5 inches of each power supply pin to ground. These capacitors reduce any potential voltage ripples from the power supply. In addition, a 10 nF ceramic capacitor should be placed as close as possible from the power supply pins on the ADCMP563/ADCMP564 to ground. These capacitors act as a charge reservoir for the device during high frequency switching.

The LATCH ENABLE input is active low (latched). If the latching function is not used, the LATCH ENABLE input may be left open or may be grounded (ground is an ECL logic high) The complementary input, LATCH ENABLE, may be left open or may be tied to  $-2.0\text{ V}$ . Leaving the latch inputs unconnected or providing the proper voltages disables the latching function.

Occasionally, one of the two comparator stages within the ADCMP563/ADCMP564 is not used. The inputs of the unused comparator should not be allowed to float. The high internal gain may cause the output to oscillate (possibly affecting the comparator that is being used) unless the output is forced into a fixed state. This is easily accomplished by ensuring that the two inputs are at least one diode drop apart, while also appropriately connecting the LATCH ENABLE and LATCH ENABLE inputs as described previously.

The best performance is achieved with the use of proper ECL terminations. The open emitter outputs of the ADCMP563/ADCMP564 are designed to be terminated through 50  $\Omega$  resistors to  $-2.0\text{ V}$ , or any other equivalent ECL termination. If a  $-2.0\text{ V}$  supply is not available, an 82  $\Omega$  resistor to ground and a 130  $\Omega$  resistor to  $-5.2\text{ V}$  provide a suitable equivalent. If high speed ECL signals must be routed more than a centimeter, microstrip or stripline techniques may be required to ensure proper transition times and prevent output ringing.

### CLOCK TIMING RECOVERY

Comparators are often used in digital systems to recover clock timing signals. High speed square waves transmitted over a distance, even tens of centimeters, can become distorted due to stray capacitance and inductance. Poor layout or improper termination can also cause reflections on the transmission line, further distorting the signal waveform. A high speed comparator can be used to recover the distorted waveform while maintaining a minimum of delay.

### OPTIMIZING HIGH SPEED PERFORMANCE

As with any high speed comparator amplifier, proper design and layout techniques should be used to ensure optimal performance from the ADCMP563/ADCMP564. The performance limits of high speed circuitry can easily be a result of stray capacitance, improper ground impedance, or other layout issues.

Minimizing resistance from source to the input is an important consideration in maximizing the high speed operation of the ADCMP563/ADCMP564. Source resistance, in combination with equivalent input capacitance, could cause a lagged response at the input, thus delaying the output. The input capacitance of the ADCMP563/ADCMP564, in combination with stray capacitance from an input pin to ground, could result in several picofarads of equivalent capacitance. A combination of 3 k $\Omega$  source resistance and 5 pF input capacitance yields a time constant of 15 ns, which is significantly slower than the 750 ps capability of the ADCMP563/ADCMP564. Source impedances should be significantly less than 100  $\Omega$  for best performance.

Sockets should be avoided due to stray capacitance and inductance. If proper high speed techniques are used, the devices should be free from oscillation when the comparator input signal passes through the switching threshold.

### COMPARATOR PROPAGATION DELAY DISPERSION

The ADCMP563/ADCMP564 have been specifically designed to reduce propagation delay dispersion over an input overdrive range of 100 mV to 1.5 V. Propagation delay overdrive dispersion is the change in propagation delay that results from a change in the degree of overdrive (how far the switching point is exceeded by the input). The overall result is a higher degree of timing accuracy because the ADCMP563/ADCMP564 are far less sensitive to input variations than most comparator designs.

# ADCMP563/ADCMP564

Propagation delay dispersion is important in critical timing applications such as ATE, bench instruments, and nuclear instrumentation. Overdrive dispersion is defined as the variation in propagation delay as the input overdrive conditions are changed (Figure 19). For the ADCMP563/ADCMP564, overdrive dispersion is typically 75 ps as the overdrive is changed from 100 mV to 1.5 V. This specification applies for both positive and negative overdrive because the ADCMP563 and the ADCMP564 have equal delays for positive and negative going inputs.

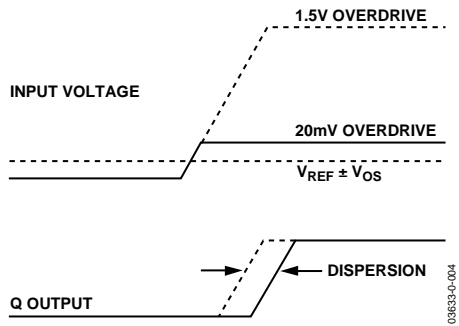

Figure 19. Propagation Delay Dispersion

## COMPARATOR HYSTERESIS

The addition of hysteresis to a comparator is often useful in a noisy environment, or where it is not desirable for the comparator to toggle between states when the input signal is at the switching threshold. The transfer function for a comparator with hysteresis is shown in Figure 20. If the input voltage approaches the threshold from the negative direction, the comparator switches from a 0 to a 1 when the input crosses  $+V_H/2$ . The new switching threshold becomes  $-V_H/2$ . The comparator remains in a 1 state until the threshold  $-V_H/2$  is crossed coming from the positive direction. In this manner, noise centered on 0 V input does not cause the comparator to switch states unless it exceeds the region bounded by  $\pm V_H/2$ .

Positive feedback from the output to the input is often used to produce hysteresis in a comparator (Figure 24). The major problem with this approach is that the amount of hysteresis varies with the output logic levels, resulting in a hysteresis that is not symmetrical around zero.

In the ADCMP564, hysteresis is generated through the programmable hysteresis pin. A resistor from the HYS pin to GND creates a current into the part that is used to generate hysteresis. Hysteresis generated in this manner is independent of output swing and is symmetrical around the trip point. The hysteresis versus resistance curve is shown in Figure 21.

A current source can also be used with the HYS pin. The relationship between the current applied to the HYS pin and the resulting hysteresis is shown in Figure 17.

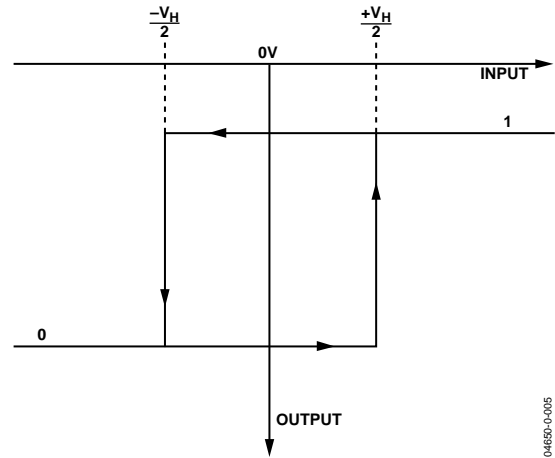

Figure 20. Comparator Hysteresis Transfer Function

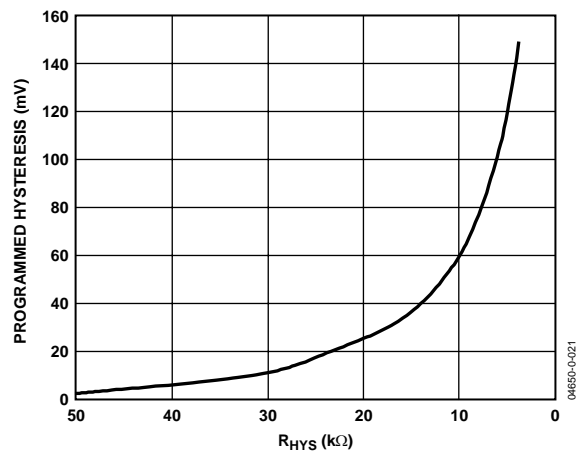
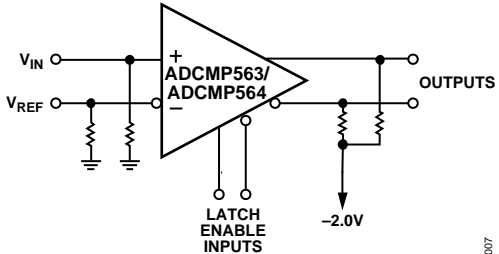

Figure 21. Comparator Hysteresis vs.  $R_{HYS}$

## MINIMUM INPUT SLEW RATE REQUIREMENT

As for all high speed comparators, a minimum slew rate must be met to ensure that the device does not oscillate when the input crosses the threshold. This oscillation is due in part to the high input bandwidth of the comparator and the parasitics of the package. Analog Devices recommends a slew rate of 1 V/ $\mu$ s or faster to ensure a clean output transition. If slew rates less than 1 V/ $\mu$ s are used, hysteresis should be added to reduce the oscillation.

TYPICAL APPLICATION CIRCUITS



ALL RESISTORS 50Ω

Figure 22. High Speed Sampling Circuits

04650-0-007

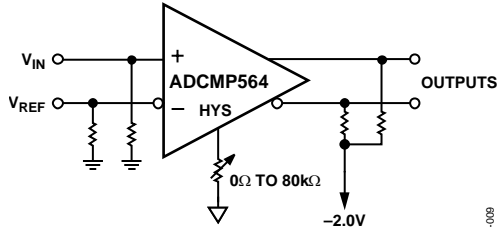

ALL RESISTORS 50Ω, UNLESS OTHERWISE NOTED

Figure 24. Adding Hysteresis Using the HYS Control Pin

04650-0-008

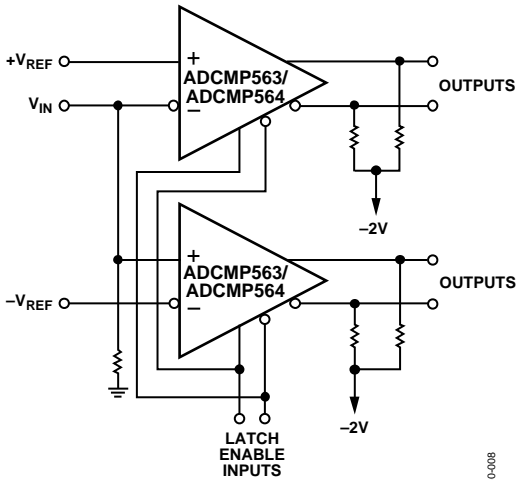

ALL RESISTORS 50Ω UNLESS OTHERWISE NOTED

Figure 23. High Speed Window Comparator

04650-0-008

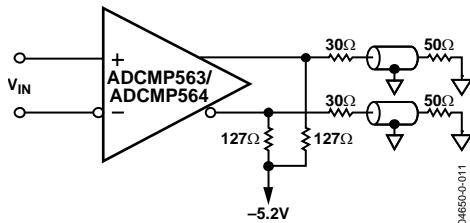
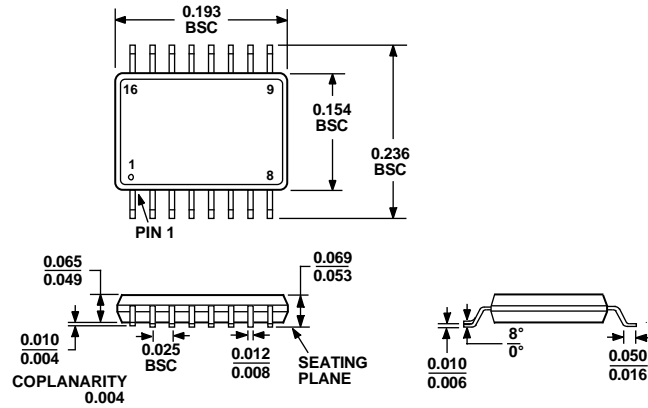

Figure 25. How to Interface an ECL Output to an Instrument with a 50Ω to Ground Input

04650-0-011

# ADCMP563/ADCMP564

## OUTLINE DIMENSIONS



COMPLIANT TO JEDEC STANDARDS MO-137AB

Figure 26. 16-Lead Shrink Small Outline Package [QSOP] (RQ-16)  
Dimensions shown in inches

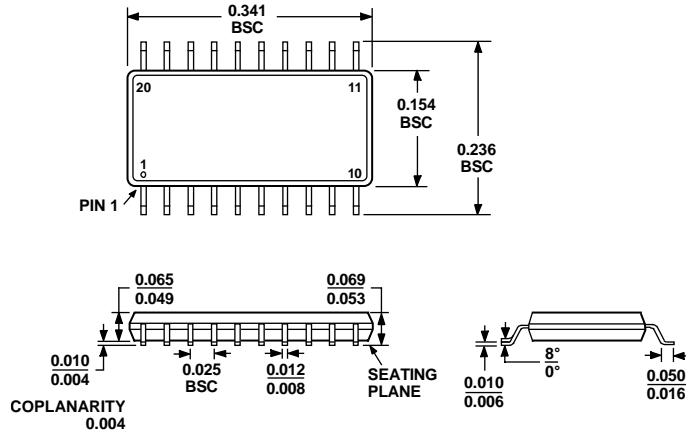

COMPLIANT TO JEDEC STANDARDS MO-137AD

Figure 27. 20-Lead Shrink Small Outline Package [QSOP] (RQ-20)  
Dimensions shown in inches

## ORDERING GUIDE

Model	Temperature Range	Package Description	Package Option
ADCMP563BRQ	-40°C to +85°C	16-Lead QSOP	RQ-16
ADCMP564BRQ	-40°C to +85°C	20-Lead QSOP	RQ-20

**NOTES**

**NOTES**



This datasheet has been download from:

[www.datasheetcatalog.com](http://www.datasheetcatalog.com)

Datasheets for electronics components.